



## 產 品 承 認 書

### SPECIFICATION FOR APPROVAL

客戶名稱 Customer Name : \_\_\_\_\_

產品型號 Product Name :           P2835Y-C2-C2          

樣品單號 Sample No : \_\_\_\_\_

版本號 Version No :                           Rev6.0                          

日 期 Date : \_\_\_\_\_

### 客戶承認簽章

#### Customer confirm and sign

檢 查 TESTED BY	核 對 CHECKED BY	承 認 APPROVED BY
審 核 結 果 INSPECT RESULT	<input type="checkbox"/> 合 格 ACCEPT	<input type="checkbox"/> 不 合 格 REJECT
說 明 (REMARK) : _____ _____		



## 1、產品外觀



## 2、產品特徵 Product features

- 封裝尺寸：3.5(長)×2.8(寬)×0.8(高) mm  
Package Size : 3.5(L) ×2.8(W) ×0.8(H) mm
- 發光顏色：黃光  
Emitted Color : Yellow
- 封裝膠體顏色：無色透明  
Lens Typs : Water Clear
- 發光角度：120°  
Viewing Angle : 120°
- 根據 ANSI 標準分檔  
According to the ANSI standard colour gamut
- 適用於所有的 SMT 組裝和焊接工藝  
All SMT assembly methods
- 符合 RoHS 標準  
RoHS compliant methods
- 可供白光色溫範圍：1400K-100000K  
Can provide white light color temperature range: 1400-100000K
- 包裝：4000PCS/包  
Package:4000pcs/reel



## 3、產品應用 Product Applications

- 室內照明：燈條、矽膠擠出燈條、注塑模組、超聲波模組、天花燈

Indoor lighting: Light bar, silicone extruded light bar, injection molding module, ultrasonic module, ceiling light

- 室外照明：景觀照明、亮化工程、洗牆燈、點光源、路燈、投光燈、泛光燈、園林燈

Outdoor lighting: landscape lighting, lighting projects, wall washer lights, point light sources, street lights, flood lights, flood lights, garden lights

- 影視、攝影照明：補光燈、平板燈、氛圍燈

Film and television, photography lighting: fill light, flat light, atmosphere light

- 舞臺燈光：幕牆、追光燈、光束燈、搖頭燈、PAR 燈

Stage lighting: curtain wall, follow light, beam light, moving head light, PAR light

- 汽車照明：剎車燈、轉向燈、氛圍燈、閱讀燈、汽車儀錶背光指示

Automotive lighting: brake lights, turn signals, atmosphere lights, reading lights, automobile instrument backlight indication

- 背光指示：LCD 背光源、TV 背光源、指示燈、閃光燈

Backlight indication: LCD backlight, TV backlight, indicator light, flash

- 生鮮、植物、醫療、功能性照明：全光譜水族燈、全光譜平板燈、全光譜燈管、美容美甲、

UV 固化、殺菌消毒產品

Fresh, botanical, medical, and functional lighting: full-spectrum aquarium lamps, full-spectrum panel lamps, full-spectrum lamps, beauty nails,

UV curing, sterilization products

- 其他照明和顯示類

Other lighting and display

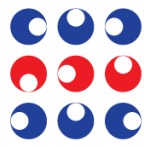

## 4、產品尺寸 Product Size

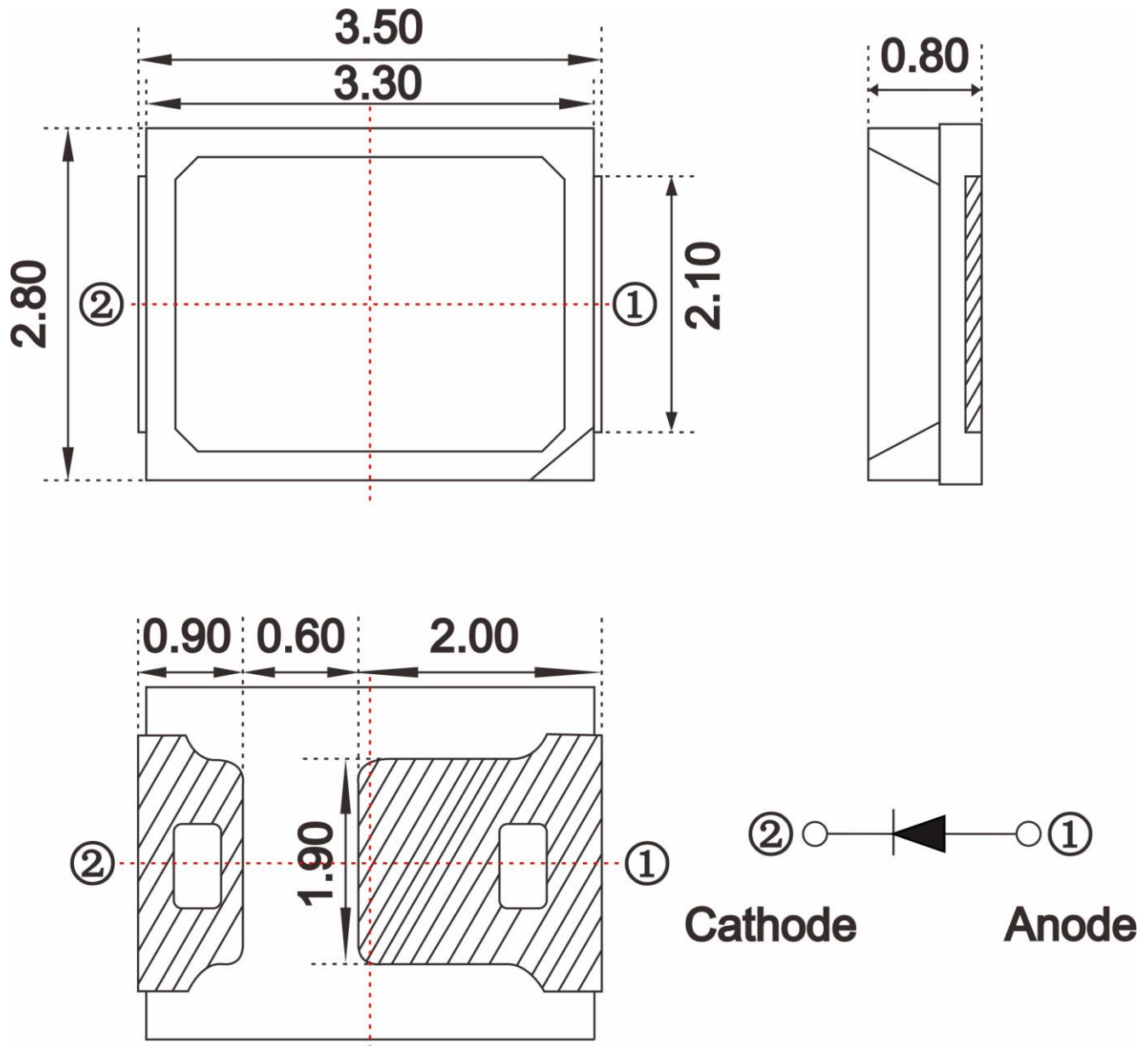

### 注釋 Notes :

1、所有的尺寸均以毫米 mm(英寸) All dimensions are in millimeters (inches).

2、除特別標注外，所有尺寸允許公差 $\pm 0.1$ mm All dimension tolerance is  $\pm 0.1$ mm unless otherwise noted.



## 5、產品性能 Product performance

極限參數 Absolute maximum ratings		(TA=25°C)	
參數 Parameter	符號 Symbol	額定值 Rating	單位 Unit
功耗 Power Dissipation	Pd	500	mW
正向電流 Forward Current	I <sub>F</sub>	150	mA
峰值正向電流 Peak Forward Current	I <sub>FP</sub>	350	mA
反向電壓 Reverse Voltage	V <sub>R</sub>	5	V
工作溫度 Operating Temperature	Topr	-40 ~+100	°C
儲存溫度 Storage Temperature	Tstg	-40 ~+125	°C
焊接溫度 Soldering Temperature	Tsol 回流焊 (260°C10 秒) Reflow soldering(260°C for 10sec)		

備註：I<sub>FP</sub> 脈衝寬度≤10ms，占空比≤1/10

Notes：I<sub>FP</sub> conditions with pulse width≤10ms，duty cycle≤1/10

光電特性 Electro-optical characteristics		(TA=25°C)				
參數 Parameter	測試條件 Test Condition	符號 Symbol	數值 Value			單位 Unit
			Min	Typ	Max	
主波長 Dominant Wavelength	I <sub>F</sub> =150mA	λ <sub>d</sub>	585	----	595	nm
正向電壓 Forward Voltage	I <sub>F</sub> =150mA	V <sub>f</sub>	2.0	----	2.6	V
光通量 Luminous Flux	I <sub>F</sub> =150mA	Φ	14	----	16	lm
角度 Viewing Angle	I <sub>F</sub> =150mA	2θ1/2	----	120	----	deg
反向電流 Reverse Current	V <sub>R</sub> =5V	I <sub>R</sub>	----	----	10	μA

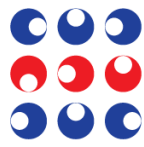

## 6、波段分檔 Wavelength Groups (IF=150mA , Ta=25°C)

Rank	A	F	G
WLD	580-585	585-590	590-595

備註：單位 nm，波段測試誤差±1 Notes：Unit nm,Wavelength Tolerance is:±1.

## 7、亮度分檔 Luminous Flux Groups (IF=150mA , Ta=25°C)

Rank	B9	C1	C2	C3	C4
Φ	10-12	12-14	14-16	16-18	18-20

備註：單位 lm，亮度測試誤差±3% Notes：Unit lm,Luminous Flux Tolerance is:±3%.

## 8、電壓分檔 Voltage Groups (IF=150mA , Ta=25°C)

Rank	03	04	05	06
Vf	1.8-2.0	2.0-2.2	2.2-2.4	2.4-2.6

備註：單位 V，電壓測試誤差±0.1V Notes：Unit V,Forward Voltage(Vf):±0.1V.



## 9、光電特徵曲線

### Typical Electro-Optical Characteristics Curves(IF=150mA, Ta=25°C)

#### Relative intensity VS.Wavelength

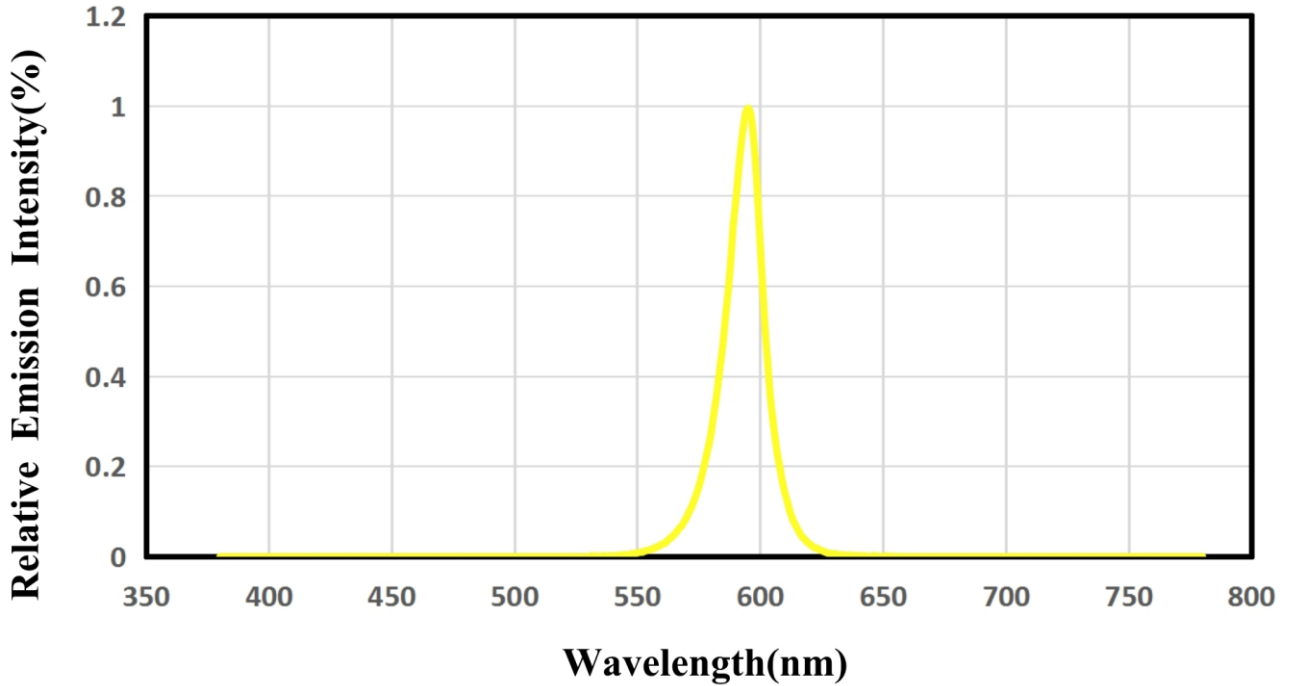

#### Radiation Characteristics

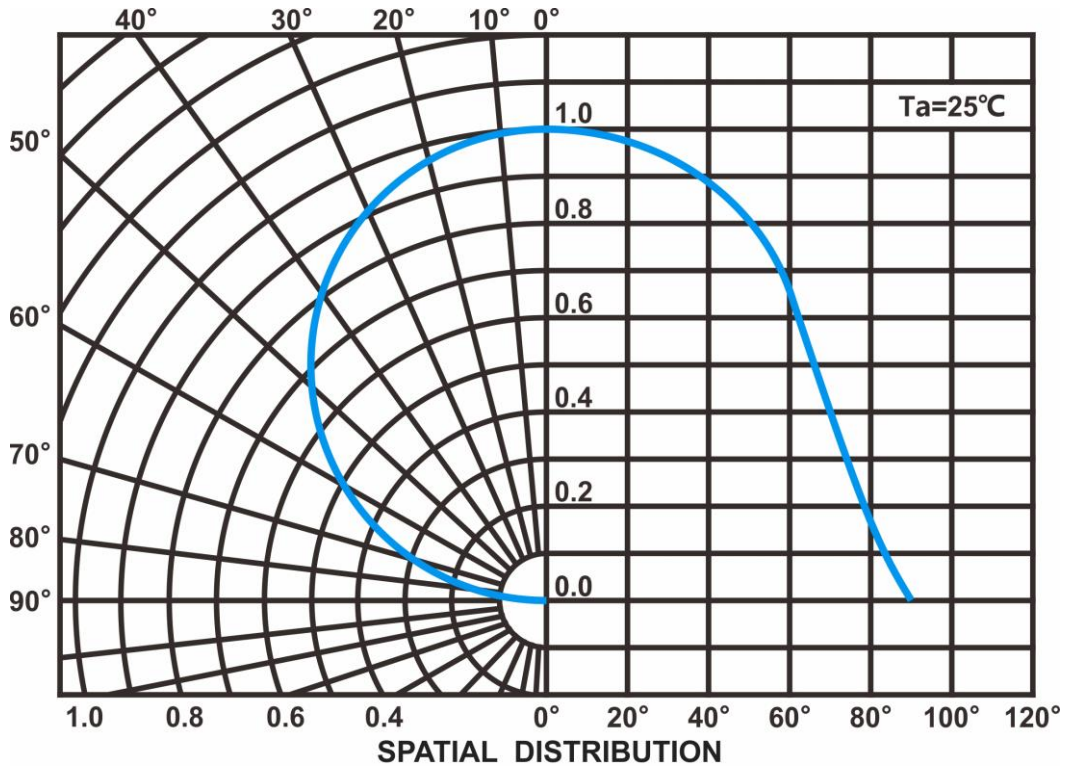



## 9、光電特徵曲線

### Typical Electro-Optical Characteristics Curves( $I_F=150\text{mA}$ , $T_a=25^\circ\text{C}$ )

Forward Current VS. Forward Voltage

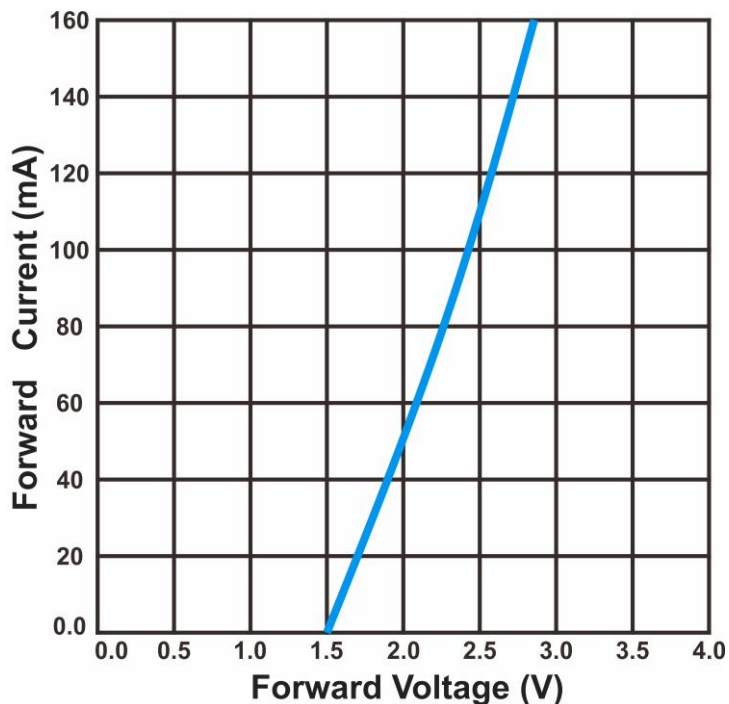

Relative Luminous Intensity VS. Forward Current

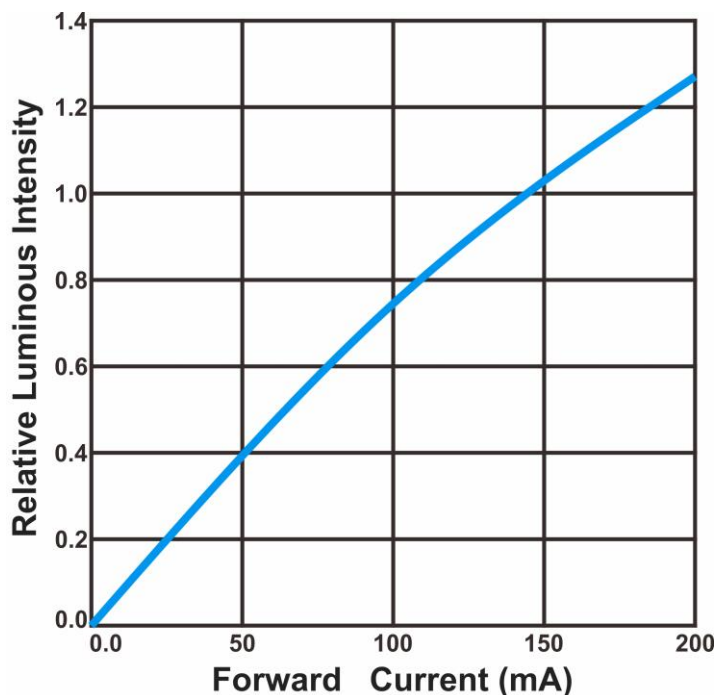

Allowable Forward Current VS. Ambient Temperature

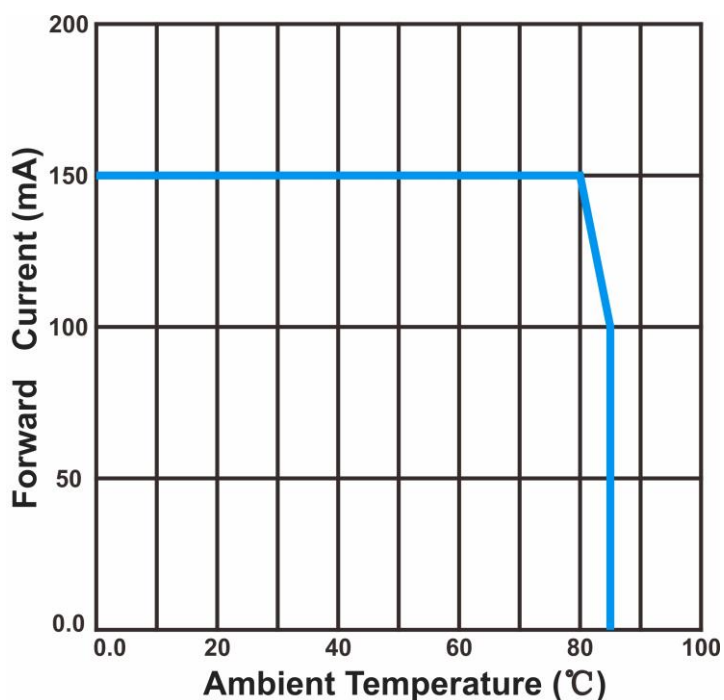

Relative Intensity VS. Ambient Temperature

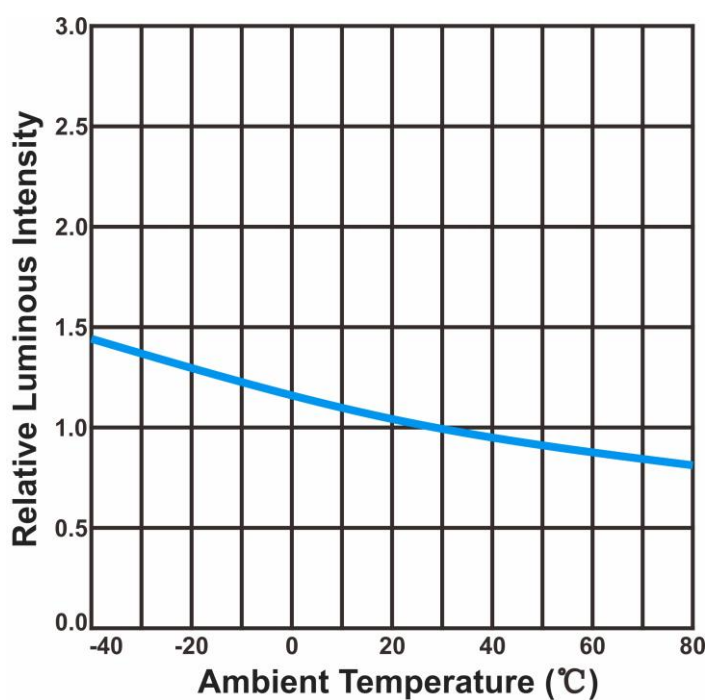





## 10、可靠性試驗專案和條件 Reliability Test Items And Conditions

可靠性實驗 Reliability Test Items And Conditions					
實驗項目 Test Items	參考標準 Reference	實驗條件 Test Conditions	時間 Time	樣品數 Quantity	判據 Criterion
冷熱衝擊 Thermal Shock	MIL-STD-202G	-20°C (30min) +80°C (30min)	100迴圈 100 Cycles	22	0/22
濕熱迴圈 Temperature And Humidity Cyclic	JEITA ED-4701 200 203	-10°C~65°C ; 0%~90%RH	10迴圈 10cycles	22	0/22
高溫儲存 High Temperature Storage	JEITA ED -4071 200 201	Ta=100°C	1000H	22	0/22
低溫儲存 Low Temperature Storage	JEITA ED -4071 200 202	Ta=-40°C	1000H	22	0/22
高溫高濕儲存 High Temperature High Humidity Storage	JEITA ED -4071 100 103	Ta=60°C ; RH=90%	1000H	22	0/22
高溫壽命 High Temperature Life Test	JESD22-A108D	Ta=80°C	1000H	22	0/22
常溫壽命試驗 Life Test	JESD22-A108D	Ta=25°C IF=150mA	1000H	22	0/22
耐焊接熱 Resistance to Sodering Heat	GB/T 4937,II , 2.2&2.3	Tsol*=(240±5) °C10secs	2次 2 times	22	0/22

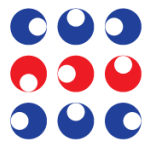

## 10、可靠性試驗專案和條件 Reliability Test Items And Conditions

### 失效判斷標準 Criteria For Judging Damage

測試項目 Test Items	符號 Symbol	測試條件 Test Conditions	判定標準 Criteria For Judging Damage
正向電壓 Forward Voltage	$V_f$	$I_F=I_{FT}$	初始值±10% Initial Data±10%
反向電流 Reverse Current	$I_R$	$V_R=5V$	$I_R \leq 10\mu A$
光強 Luminous Intensity	IV	$I_F=I_{FT}$	平均 $I_V$ 衰減≤30%；單個 $I_V$ 衰減≤50% Average $I_V$ degradation≤30%；Single LED $I_V$ degradation≤50%
耐焊接熱 Resistance to Soldering Heat		材料內部無裂痕、無材料間爆裂、剝離、無死燈 Material without internal cracks, no material between stripped, no dead light	

\*備註：Tsol-錫液溫度 \*Notes Tsol-Temperature of tin liquid

## 11、產品編碼規則 Product coding rules

### 11.1 命名規則 Naming rules

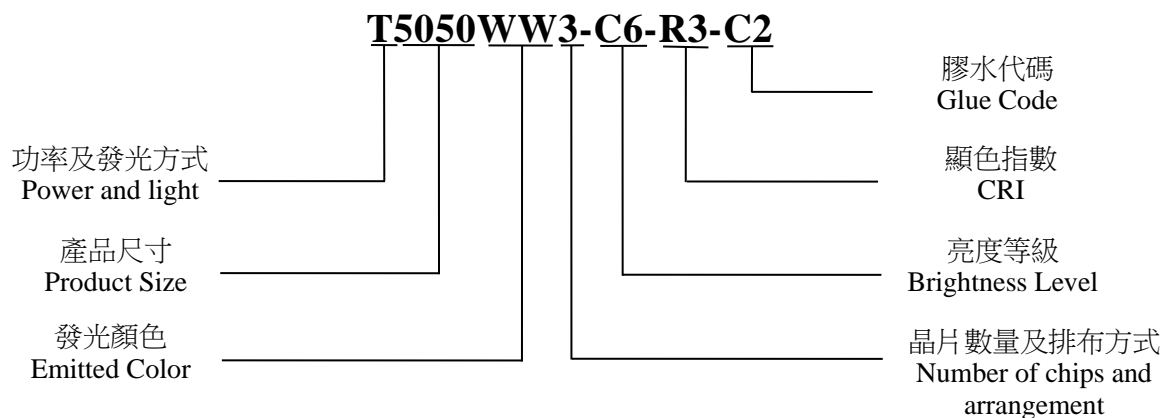



## 11、產品編碼規則 Product coding rules

### 11.2 Bin Code 描述 Bin Code Description

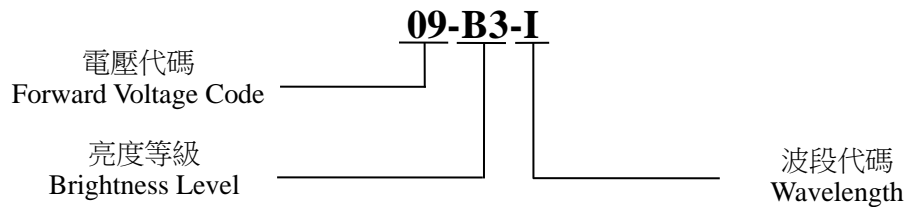

## 12、標籤條碼 Label barcode

① Ltem:T2835B-B3-C2

② Lot No:130502101



③ I F : 1 5 0 0 m A

④ WL:460-465NM                      ⑦ Bin Code:09-B3-I

⑤ IV:1200-1500MCD                  ⑧ V F : 3 . 0 - 3 . 2 V

⑥ Date:2012-05-02                    ⑨ Q T Y : 4 0 0 0 P C S

⑩ 分光產品，請分 Bin 使用，使用前請使用 70°C 連續烘烤 12 小時以上

### 12.1 標籤說明 Label description

①	產品代碼	Product Code
②	生產批號	Generate batch numbe
③	測試電流	Test current
④	波長	Wavelength
⑤	亮度	Brightness
⑥	日期	Date
⑦	Bin Code	
⑧	正向電壓	Forward Voltage
⑨	數量	Quantity
⑩	提示	Prompt

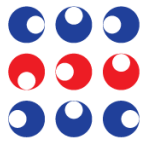

## 13、包裝 Packing

### 13.1 載帶 Carrier Tape

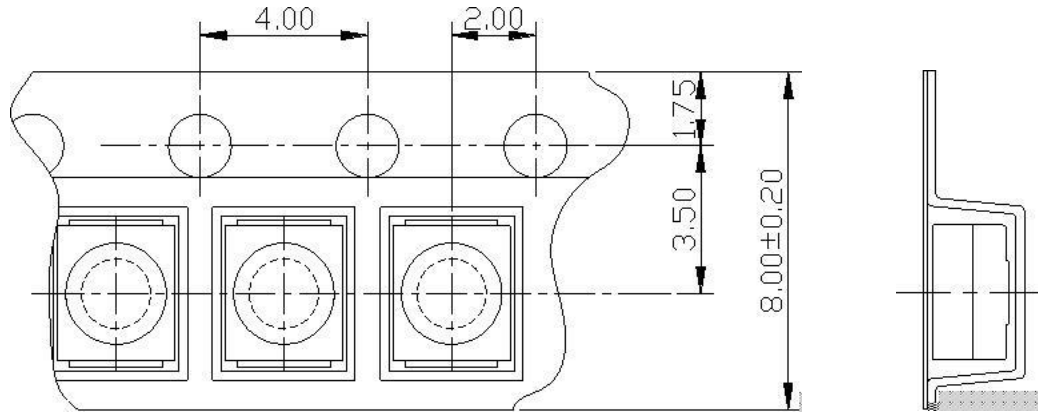

備註：單位 mm，未注公差： $\pm 0.1$  mm Notes: All dimensions in mm, tolerances unless mentioned is  $\pm 0.1$  mm.

### 13.2 編帶細節 Details Of Carrier Tape

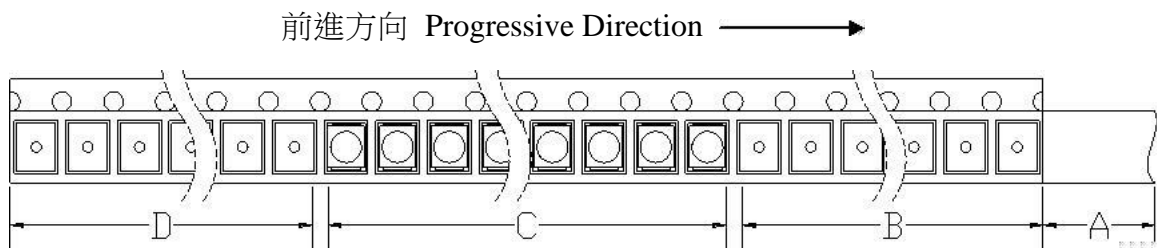

備註：A：蓋帶，300 mm；B：引導，空帶，200mm；C：編載產品 4000只；D：尾部，空帶，200mm  
Notes：A: Top Cover Tape, 300mm; B: Leader, Empty, 200mm; C: 4000 Lamps Loaded; D: Trailer, Empty, 200mm.

### 13.3 卷盤 Reel Dimension

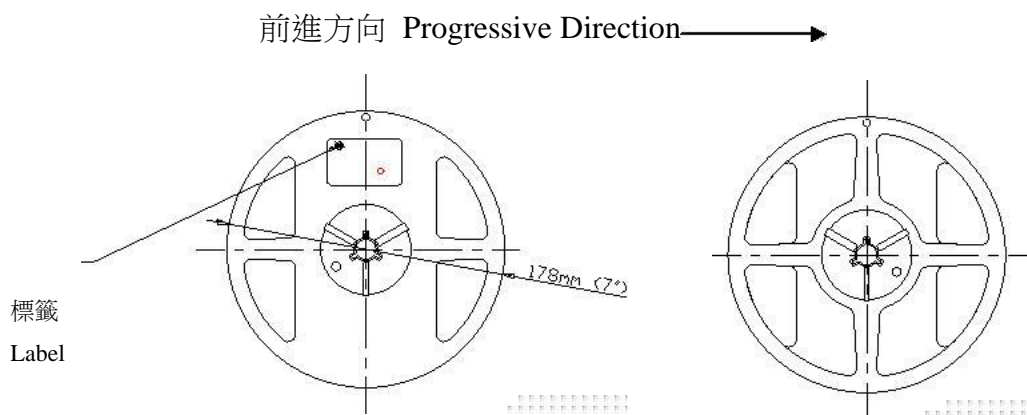

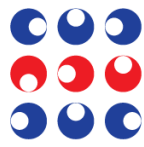

## 13、包裝 Packing

### 13.4 防潮抗靜電包裝 Moistureproof Antistatic Packaging

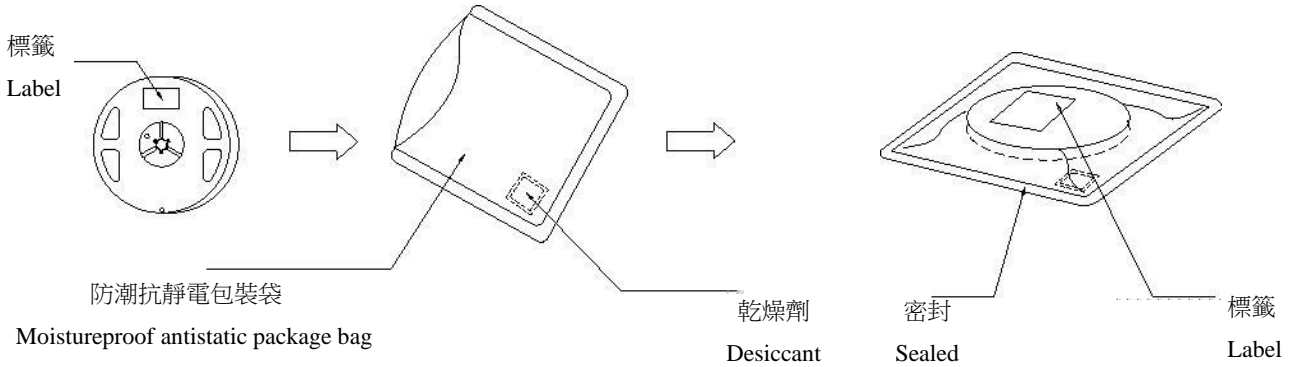

### 13.5 外包裝箱 Cardboard Box

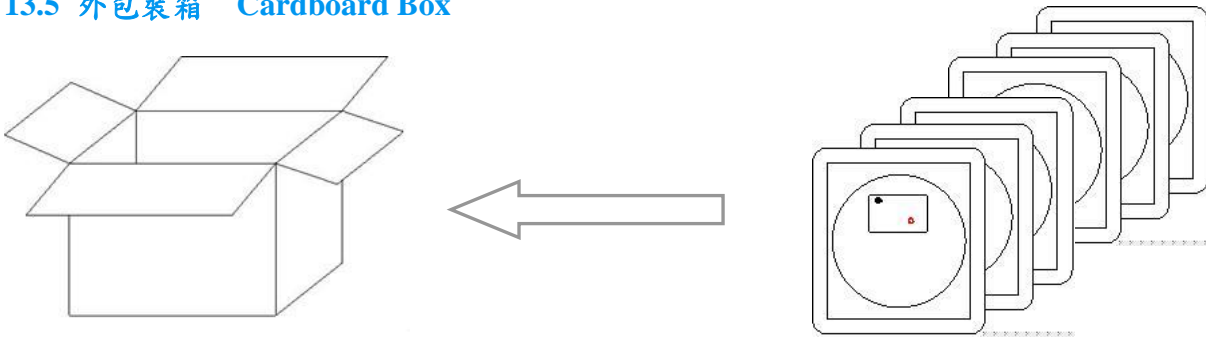

## 14、回流焊特性 Reflow Soldering Characteristics

### 14.1 回流焊曲線圖 Reflow Soldering Curve

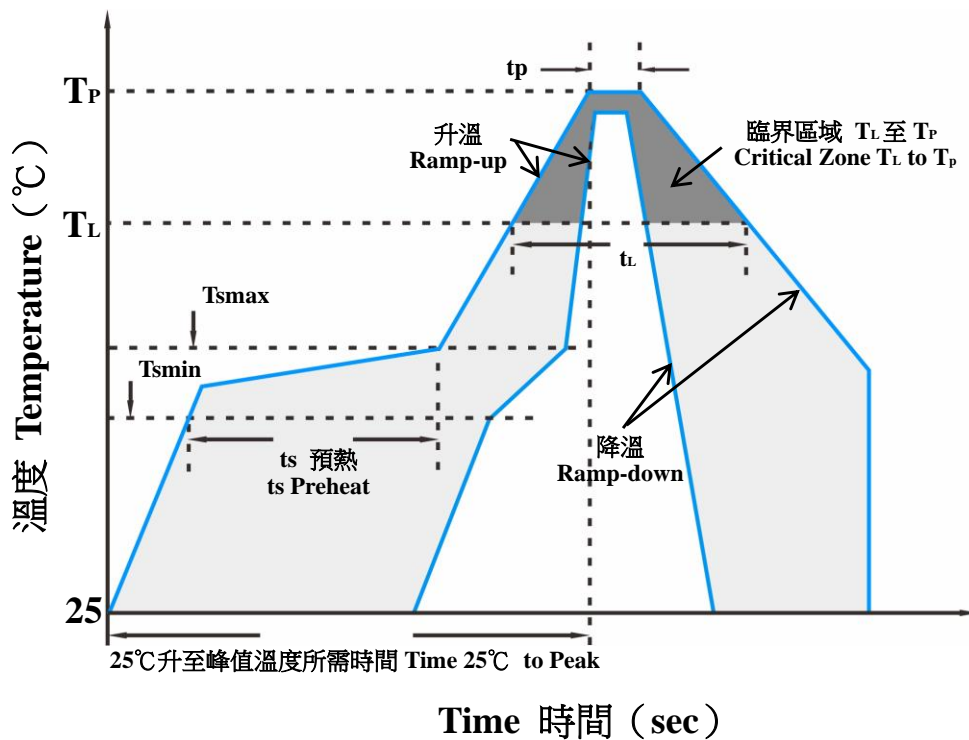

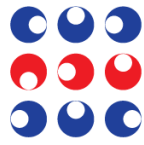

## 14、回流焊特性 Reflow Soldering Characteristics

### 14.2 回流焊溫度變化 Reflow Soldering Temperature Change

分佈特徵 Profile Feature	含鉛回流焊 Pb-Based Assembly	無鉛回流焊 Pb-Free Assembly
平均升溫速度 (TSmax-Tp) Average heating rate (TSmax-Tp)	3°C/seconds max	3°C/seconds max
最低預熱溫度 (TSmin) The lowest preheating temperature (TSmin)	100°C	150°C
最高預熱溫度 (TSmax) Maximum preheating temperature (TSmax)	150°C	200°C
預熱時間 (tsmin-tsmax) Warm-up time (tsmin-tsmax)	60~120 seconds	60~180 seconds
溫度 (TL) Temperature (TL)	183°C	217°C
維持在 TL 以上時間 (tL) Time above TL (tL)	60~150 seconds	60~150 seconds
峰值溫度(Tp) Peak Temperature(Tp)	225°C	260°C
峰值溫度限時時間 (tp) Peak temperature time limit(tp)	Not more than 10 second	Not more than 20 second
維持與實際波峰(tp)低於 5°C 以內的時間 Maintain the time within 5 °C of the actual peak (tp)	Not more than 30 second	Not more than 40 second
降溫速度 Ramp-down Rate	6°C/seconds max	6°C/seconds max
從 25°C 升至峰值溫度所需時間 Time 25°C to peak Temperature	6 minutes max	8 minutes max

### 14.3 回流焊注意事項 Precautions For Reflow Soldering

a：請選擇合適的吸嘴大小和壓力，以避免對產品產生不良隱患。

Please choose the appropriate nozzle size and pressure to avoid undesirable hidden dangers to the product.

b：回流焊最多只能進行兩次。

Reflow soldering should not be done more than two times.

c：在回流焊升溫過程中，請不要對 LED 施加任何壓力。

Stress on the LEDs should be avoided during heating in soldering process.

d：在焊接完成後，待產品溫度下降到室溫之後，再進行其它處理。

After soldering, do not deal with the product before its temperature drop down to room Temperature.

e：在焊接完成後，切勿彎曲線路板。

After soldering, do not warp the circuit board.



## 14、回流焊特性 Reflow Soldering Characteristics

### 14.4 手工焊接 Hand Soldering

a：不推薦，易損壞 LED。

Not recommended, easy to damage LED.

b：推薦使用功率低於 20W 的烙鐵，焊接時烙鐵的溫度必須保持在 360°C 以下，且每個電極只能進行一次焊接，每次焊接的持續時間不得超過 3 秒。

Soldering iron of less than 20W is recommended to be used in Hand Soldering. Please keep the temperature for the soldering iron under 360°C while soldering. Each terminal for the LED is to go for less than 3 second and for one time only.

c：人手焊接過程中不慎操作易引起 LED 產品的損壞，應當小心謹慎。

Be careful because the damage of the product is often started at the time of the hand soldering.

## 15、使用注意事項 Precautions for use

### 15.1 烘烤除濕標準 Standard For Drying And Dehumidification

a：卷裝：除濕方法，去掉靜電袋，在使用前請將產品放在 65-70°C 烤箱中連續烘烤 ≥24 小時。

Package: Dehumidification method, remove the static bag, put the product in the oven at 65-70 °C for continuous baking for more than 24 hours before use.

b：散數：除濕方法，在使用前請將產品放在 150-160°C 烤箱中連續烘烤 ≥2 小時。

Bulk number: Dehumidification method, please place the product in the 150-160 °C oven for continuous baking for more than 2 hours before use.

c：從烤箱中拿出來後請在 4 小時內立即使用完畢。

Please take it within 4 hours after taking it out of the oven.

### 15.2 貯存 Storage

a：本產品使用密封防潮抗靜電袋包裝，並附有乾燥劑，未開封的產品有一年的保存時間。

This product is packaged in a sealed moisture-proof and anti-static bag with a desiccant. The unopened product has a storage time of one year.

b：開封前，產品須存放在溫度不高於 30°C，濕度不高於 60%RH 的環境中。

Before opening the package, the product should be kept at 30°C or less and humidity less than 60% RH, and be used within a year.



## 15、使用注意事項 Precautions for use

### 15.2 貯存 Storage

c：開封後，產品須存放在溫度不高於 30°C，濕度不高於 10%RH 的環境中，且應該在 4 小時內使用完。建議工作環境為溫度不高於 30°C，濕度不高於 60%RH。

After opening the package, the product should be stored at 30°C or less and humidity less than 10%RH, and besoldered within 4 hours . It is recommended that the product be operated at the workshop condition of 30°C or less and humidity less than 60%RH.

d：對於尚未焊接的 LED，如果吸濕劑或包裝失效，或者產品沒有符合以上有效存儲條件，烘焙可以起到一定的性能恢復效果。烘焙條件：(65-70) °C，持續 24 小時。

If the moisture absorbent material has fade away or the LEDs have exceeded the storage time, baking treatment should be performed based on the following condition: (65-70)°C for 24 hours.

### 15.3 靜電 Static Electricity

a：靜電和電湧會導致產品特性發生改變，例如正向電壓降低等，如果情況嚴重甚至會損毀產品。所以在使用時必須採取有效的防靜電措施。

Static electricity and surges can cause changes in product characteristics, such as a reduction in forward voltage, etc. If the situation is serious, it can even damage the product. Therefore, effective anti-static measures must be taken during use.

b：所有相關的設備和機器都應該正確接地，同時必須採取其他防止靜電和電湧的措施。

All related equipment and machines should be properly grounded, and other measures to prevent static electricity and surges must be taken.

c：使用防靜電手環，防靜電墊子，防靜電工作服、工作鞋、手套，防靜電容器，都是有效的防止靜電和電湧的措施。

The use of anti-static bracelets, anti-static mats, anti-static work clothes, work shoes, gloves, and anti-static containers are all effective measures to prevent static electricity and surges.

### 15.4 眼睛保護忠告 Safety Advice For Human Eyes

a：LED 發光時，請勿直視發光光源，特別是對於一些光強較高的 LED，強光可能傷害你的眼睛。

Viewing direct to the light emitting center of the LEDs, especially those of great Luminous Intensity will cause great hazard to human eyes. Please be careful.





## 15、使用注意事項 Precautions for use

### 15.5 硫化 Vulcanization

a：LED 硫化是由於環境中的硫進入支架內部與+1 價的銀發生化學反應生成黑色  $Ag_2S$  的過程。該過程會導致支架鍍銀層的反光能力下降，色溫漂移和光衰嚴重，很大程度上影響了產品性能。因此，在使用時應注意採取相應的防硫措施，如避免使用揮發性強的含硫物質，避免接觸含硫較高的物質。

LED curing is due to sulfur being in bracket and the +1 price of silver in the chemical reaction generated  $Ag_2S$  in the process. It will lead to the capacity of reflecting of silver layer reducing, light color temperature drift and serious decline ,seriously affecting the performance of the product.So we should take corresponding measures to avioding vulcanization, such as to avoid using sulphur volatile substances and keeping away from high sulphur content of the material.

b：LED 工作環境及 LED 適配的材料中硫元素及化合物成分不可超過 100PPM。  
LED operating environment and sulfur element coposition cannot be over 100PPM in the LED mating usage materiall.

c：在使用外封膠塗抹 LED 產品時，應確保外封膠與 LED 封裝膠水相匹配，因為大多數 LED 的封裝膠水為矽膠，它有較強的氧化性和較強的吸濕性，必須防止外封材質進入 LED 內部以造成 LED 損傷，單一的溴元素含量要求小於 900PPM，單一氯元素含量要求小於 900PPM，在塗抹 LED 產品時要求外封膠溴元素與氯元素總含量必須小於 1500PPM。

When using outer sealant to paint LED products, make sure that the outer sealant matches the LED encapsulation glue, because most LED encapsulation glue is silica gel, which has strong oxidation and strong hygroscopicity, and must be prevented from being sealed. The material enters the interior of the LED to cause LED damage. The single bromine element content is less than 900PPM, and the single chlorine element content is less than 900PPM. When applying LED products, the total content of bromine and chlorine elements in the outer sealant must be less than 1500PPM.

d：LED 不可用在 PH<7 的酸性環境。  
Not suitable to operate in acidic environment,PH<7.





## 15、使用注意事項 Precautions for use

### 15.6 其他 Other

a：為確保 LED 的可靠性，在操作過程中不可施加壓力在 LED 器件膠體表面。

In order to ensure the reliability of the LED, no pressure should be applied on the colloidal surface of the LED device during the operation.

b：不可將 SMT 後的半成品材料堆積在一起，它可能會損壞 LED 內部電路。

Do not stack the semi-finished materials after SMT, it may damage the internal circuit of the LED.

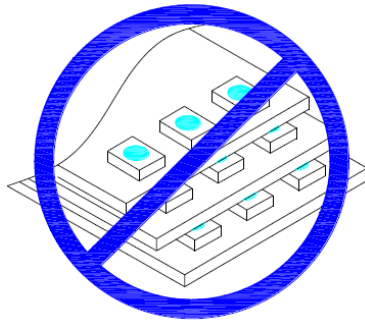

c：通過使用適當的工具從 LED 側面夾取，不可直接用手或尖銳金屬壓膠體表面，它可能會損壞 LED 內部電路。

By using appropriate tools to grab from the side of the LED, do not directly press the surface of the colloid with hands or sharp metal, it may damage the internal circuit of the LED.

