

LL-803AC3A-002

DATA SHEET

QC :

ENG :

Prepared By:

Features

- ◆ High intensity
- ◆ 8mm diameter concave package
- ◆ Wide viewing angle
- ◆ General purpose leads
- ◆ Reliable and rugged

Package Dimension:

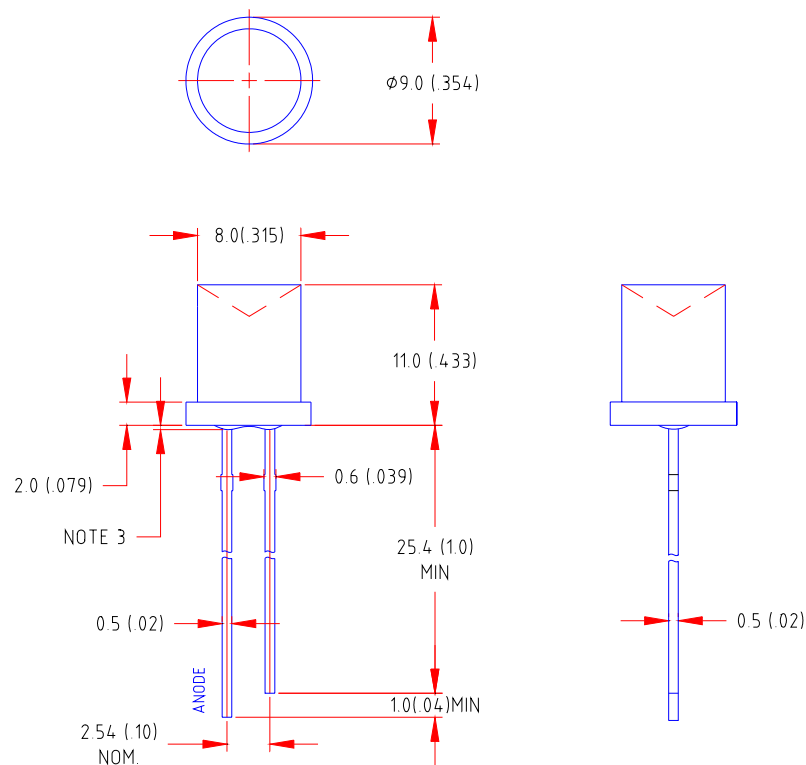

Part NO.	Chip Material	Lens Color	Source Color
LL-803AC3A-002	AlGaInP	Water Clear	Super Bright Amber

Notes:

1. All dimensions are in millimeters (inches).
2. Tolerance is ± 0.25 (.010") mm unless otherwise noted.
3. Protruded resin under flange is 1.0mm (.04") max
4. Lead spacing is measured where the leads emerge from the package.
5. Specifications are subject to change without notice

Absolute Maximum Ratings at Ta=25

Parameter	MAX.	Unit
Power Dissipation	100	mW
Peak Forward Current (1/10 Duty Cycle, 0.1ms Pulse Width)	100	mA
Continuous Forward Current	35	mA
Derating Linear From 50	0.4	mA/
Reverse Voltage	5	V
Operating Temperature Range	-40 to +80	
Storage Temperature Range	-40 to +80	
Lead Soldering Temperature [4mm(.157") From Body]	260 for 5 Seconds	

Electrical Optical Characteristics at Ta=25

Parameter	Symbol	Min.	Typ.	Max.	Unit	Test Condition
Luminous Intensity	I _v	30	70	150	mcd	I _F =20mA (Note 1)
Viewing Angle	2 _{1/2}	115	125	135	Deg	(Note 2)
Peak Emission Wavelength	λ _p	600	605	610	nm	I _F =20mA
Dominant Wavelength	λ _d	600	605	610	nm	I _F =20mA (Note 3)
Spectral Line Half-Width		15	20	25	nm	I _F =20mA
Forward Voltage	V _F	1.6	2.0	2.6	V	I _F =20mA
Reverse Current	I _R	---	---	100	μA	V _R =5V

Note:

- 1.Luminous intensity is measured with a light sensor and filter combination that approximates the CIE eye-response curve.
2. _{1/2} is the off-axis angle at which the luminous intensity is half the axial luminous intensity.
- 3.The dominant wavelength (λ_d) is derived from the CIE chromaticity diagram and represents the single wavelength which defines the color of the device.

Typical Electrical / Optical Characteristics Curves
 (25 Ambient Temperature Unless Otherwise Noted)

Spectral Radiance (Peak @ 605nm)

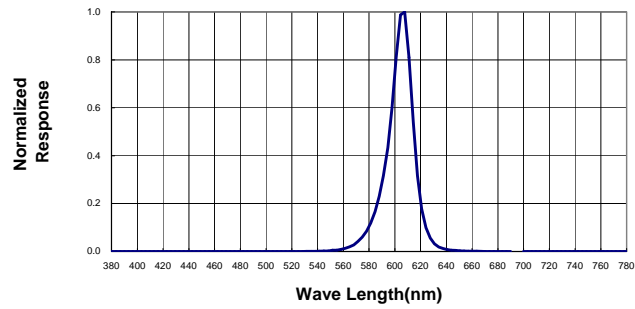

Forward Current vs Forward Voltage

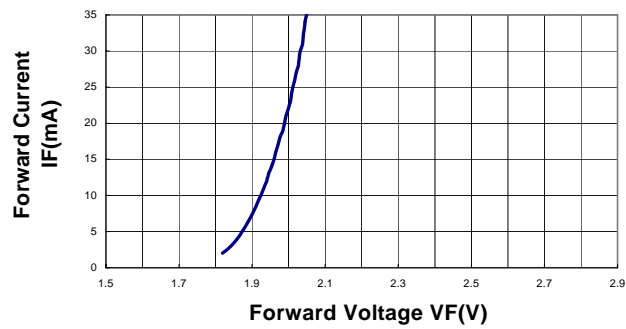

Relative Luminous Intensity vs Forward Current

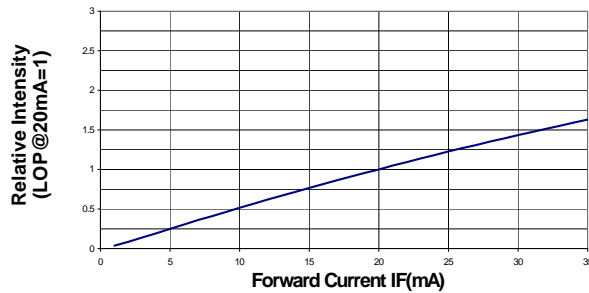

Beam Pattern

